



teknik doküman



FOÇA



“Tekli oturma için tasarlanan Foça, geniş renk seçeneğine sahip suni deri, kumaş ve keçe kaplamasıyla uyumlu ahşap ayak kombinasyonu sayesinde kullanıldığı ortamda sıcak bir atmosfer yaratıyor. Yönetici odalarından ortak kullanım alanlarına kadar konforu gözeterek, konuklarınıza ihtiyaç duydukları rahatlığı yaşıyor.”

b.design team

ürün ailesi _____

tekli koltuk - suni deri / kumaş

tekli koltuk - keçe



ölçü tablosu _____

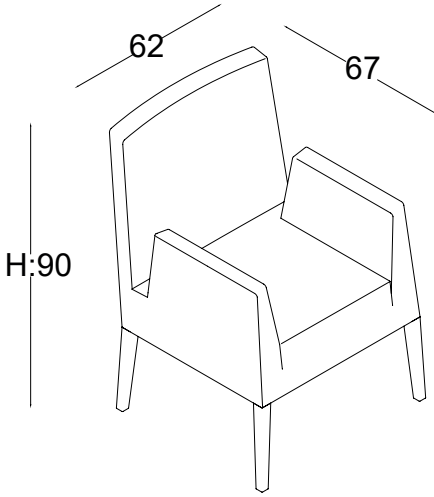

renk seçenekleri - döşeme renkleri

suni deri

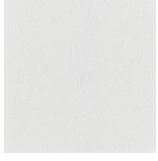

A 101
beyaz | white

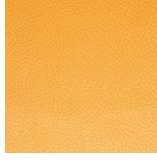

A 201
hardal | mustard

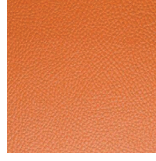

A 202
turuncu | orange

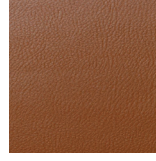

A 105
taba | ginger

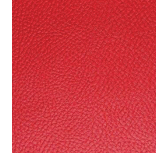

A 203
kırmızı | red

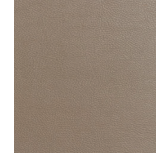

A 104
ceviz | walnut



A 102
açık krem | light cream



A 113
koyu bej | dark beige

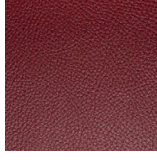

A 204
bordo | bordeaux

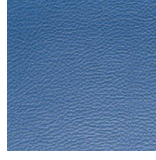

A 205
mavi | blue

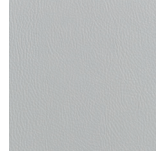

A 114
gri | grey

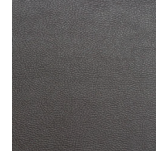

A 110
antrasit | antrachite

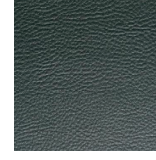

A 208
yeşil | green

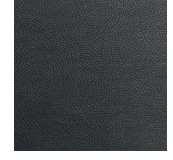

A 111
koyu kahve | dark brown

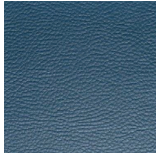

A 206
petrol mavi | petrol blue



A 207
haki | khaki

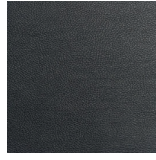

A 112
siyah | black

panama

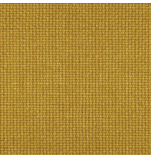

P 101
sarı | yellow

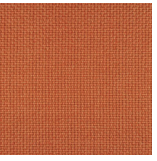

P 102
turuncu | orange

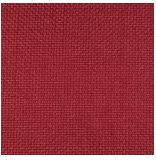

P 104
kırmızı | red

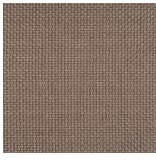

P 301
açık kahve | light brown

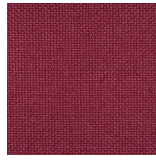

P 106
bordo | burgundy

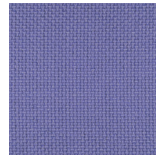

P 307
lila | lilac

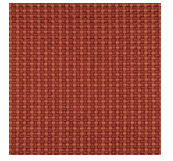

P 404
punti turuncu | punti orange

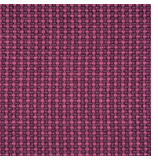

P 402
punti pembe | punti pink

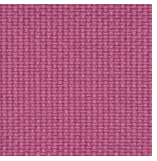

P 302
pembe | pink

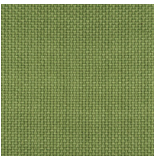

P 305
fıstık yeşili | pistachio

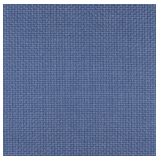

P 112
buz mavi | ice blue

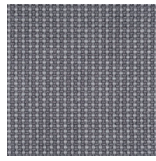

P 403
punti gri | punti grey

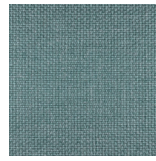

P 111
turkuaz | turquoise

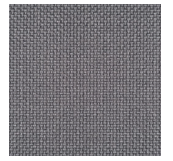

P 308
antrasit | antrachite

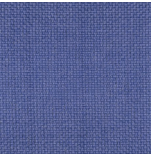

P 113
saks mavi | blue

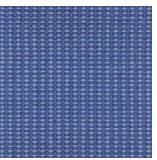

P 406
punti mavi | punti blue

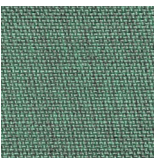

P 110
yeşil | green

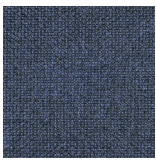

P 114
lacivert | dark blue



P 108
hardal | mustard

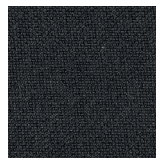

P 115
siyah | black

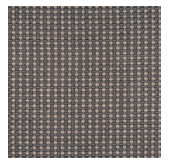

P 401
punti kahve | punti brown

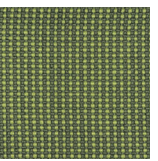

P 405
punti yeşil | punti green

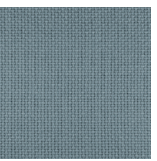

P 303
gri | grey

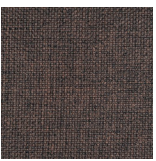

P 109
koyu kahve | dark brown

renk seçenekleri - döşeme renkleri _____

bloom



BL 2302
turuncu | orange



BL 2305
sarı | yellow

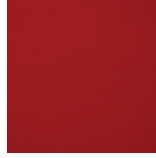

BL 2310
kırmızı | red

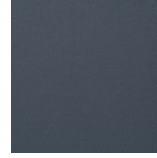

BL 2315
antrasit | antrachite

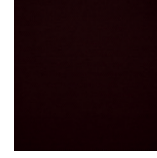

BL 2316
koyu kahve | dark brown



BL 2322
somon | salmon



BL 2324
açık gri | light grey



BL 2334
mint yeşili | mint green



BL 2327
siyah | black



BL 2338
mavi | blue



A 110
tomurcuk yeşili |
bright green



BL 2409
açık kahve | light brown

camira synergy



LDS07
leylak | lilac



LDS74
mercan | coral



LDS73
açık somon | light salmon



LDS48
zeytin yeşili | olive



LDS46
limon yeşili | lemon



LDS37
kakao | cocoa



LDS33
vizon | mink



LDS83
açık turuncu | light orange

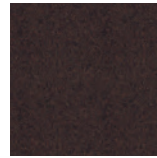

LDS39
koyu kahve | dark brown

keçe



W 101
turuncu | orange



W 102
mercan | coral



W103
kırmızı | red



W 201
krem | cream



W 202
kahve | brown



W 203
yeşil | green



W 104
gri | grey

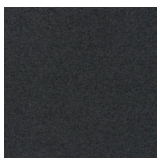

W 105
antrasit | antrachite

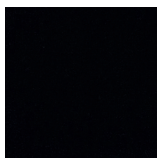

W 106
siyah | black

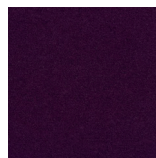

W 207
mor | purple



W 205
lacivert | dark blue



W 208
mavi | blue

renk seçenekleri - ayak renkleri _____

cila

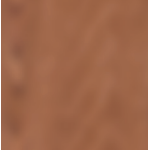

amerikan ceviz |
american walnut

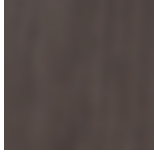

titanyum meşe |
titanium oak



venge | wenge



naturel | natural

lake



beyaz | white



gri | grey



kum | sand



antrasit | anthracite



siyah | black